

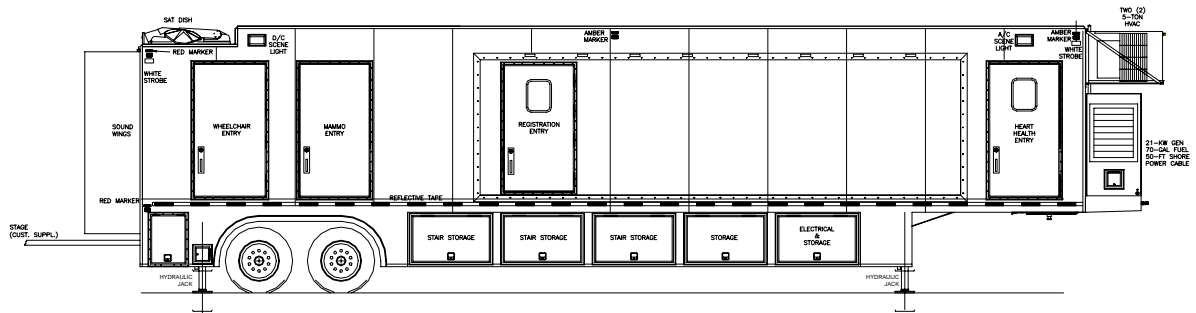

Site Planning Guide

GE MOVING EXPERIENCES Senographe 2000 D Mammography, Bone Health and Heart Health Clinic



© 2007 Oshkosh Specialty Vehicles

This guide contains confidential information of Oshkosh Specialty Vehicles. You may not copy it or any part of it without the written permission of Oshkosh Specialty Vehicles. This guide may be used only by you, and only for the purposes for which it was intended. You may not disclose this guide or the confidential information it contains outside of your company. If you wish to copy any part of this guide, or to use it other than as it described above, you must contact Oshkosh Specialty Vehicles seeking permission to do so.

North America

Corporate Headquarters
Oshkosh Specialty Vehicles
16745 South Lathrop Ave.
Harvey, IL
60426
USA
(001) 708.596.5066

Europe

Oshkosh Specialty Vehicles, Ltd.
Unit 17, Nelson Way
Tuscum Trading Estate,
Camberley, Surrey
GU15 3DH
United Kingdom
(44) 01276.64490

Buys Ballotstraat 6
3261 LA Oud-Beijerland, Holland
+31 (0) 186-614322
Fax . +31 (0) 186-619367
E-mail: smit@smit-mobile.nl

List of Revisions

Revisions

00	Initial Release	July.2003
01	Updated Logo & Company Reference	February 2007

Notice

In accordance with our policy of continued product improvement, Oshkosh Specialty Vehicles reserves the right to make changes in the equipment, design, specifications, and materials of the product described herein. Any problems or questions related to the components or systems covered in this booklet may be directed to:

Oshkosh Specialty Vehicles
Attention: Service Department
16745 South Lathrop Avenue
Harvey, Illinois
60426
USA

(001) 800.839.0630 (24 hour service)
(001) 708.596.2480 (fax)

<http://www.oshkoshsv.com/>

Table of Contents

<u>Introduction.....</u>	<u>5</u>
Warnings & Safety Alert Conventions	5
<u>Support Pad Requirements</u>	<u>7</u>
Recommended Support Pad Requirements	7
Recommended Service Pad.....	7
Support Pad Depth.....	7
Support Pad Levelness	7
Vehicle Access	7
Recommended Attachment to the Facility	7
Swing Clearance Note.....	7
Radiation Shielding.....	8
<u>Customer Power Requirements</u>	<u>9</u>
Lockout/Tagout.....	9
Electrical Service	9
Configuration	9
Load Regulation at Line Frequency	9
Frequency.....	9
Phase Balance	9
Maximum Voltage Variation	10
Connector Type.....	10
Customer Facility.....	10
Connector Notes.....	10
Voltage Surges	10
Power Source Monitoring (Facility Only).....	11
<u>Mobile Grounding Requirements</u>	<u>12</u>
Special Ground Note	12
<u>Telephone Service Requirements</u>	<u>14</u>
Telephone Service.....	14
Data Service	14
<u>Water Requirements.....</u>	<u>15</u>
Fresh Water Supply Requirements	15
Water Tank Drain Connections	15

Table of Figures

Figure 1: Pad Layout	16
Figure 2: Right Side Elevation.....	17
Figure 3: Left Side Elevation	18
Figure 4: Rear Side Elevation	19
Figure 5: Russellstoll Service Outlet	20
Figure 6: Russellstoll 480V Chart.....	21
Figure 7: Turning Requirements	22

Introduction

The purpose of this document is to provide the basic information needed for site planning. For specific information not contained in this document, please contact Oshkosh Specialty Vehicles.

The mobile unit requires sufficient room to be maneuvered and positioned for setup and takedown. The mobile unit has many storage compartments and service doors that require access during these procedures as well as during operation. The wheel chair lift, entry stair and optional platform require additional space on each side of the mobile self-propelled unit. Refer to the drawings provided for actual locations of doors, wheel chair lift, and stair sizes and locations.

Warnings & Safety Alert Conventions

The following terms define the various precautions and notices used in this manual:

NOTE:

Whenever information exists that requires additional emphasis beyond the standard textual information, the term “NOTE” is used.

IMPORTANT

Whenever information exists that requires special attention to procedures to ensure proper operation of the equipment or to prevent its possible failure, the term “IMPORTANT” is used.



Whenever potential damage to equipment exists, requiring correct procedures / practices for prevention, the term “CAUTION” is used.



Whenever potential personal injury or death situations exist, requiring correct procedures / practices for prevention, the term “WARNING” is used.



Whenever immediate hazards exist that could result in personal injury or death that cannot be eliminated by design safeguards, the term “DANGER” is used.



This safety alert symbol indicates important safety messages in the manual. When you see this symbol, carefully read the message that follows and be alert to the possibility of personal injury or death.



Electrical, mechanical, pneumatic, and hydraulic safety devices have been installed on this vehicle to help protect against personal injury and / or damage to equipment. Under no circumstances should any attempt be made to disconnect or in any way render any of these devices inoperative. If a malfunction of any safety device is discovered to exist, DO NOT operate the vehicle, but immediately notify appropriate maintenance personnel.

Oshkosh Specialty vehicles shall have no liability with respect to: REPAIRS IMPROPERLY PERFORMED OR REPLACEMENTS IMPROPERLY INSTALLED (or) USE OF REPLACEMENT PARTS OR ACCESSORIES NOT CONFORMING TO Oshkosh SPECIALTY VEHICLE'S SPECIFICATIONS, WHICH ADVERSELY AFFECT PERFORMANCE OR DURABILITY (or) ALTERATIONS OR MODIFICATIONS NOT RECOMMENDED OR APPROVED IN WRITING BY Oshkosh SPECIALTY VEHICLES (or) FOR EQUIPMENT DAMAGE OR PERSONAL INJURY OR DEATH AS A RESULT OF RENDERING ANY SAFETY DEVICE INOPERABLE.

Certain inherent risks are associated with heavy trailers due to the nature of their use. Personnel working in the area of these trailers are subject to certain hazards that cannot be met by mechanical means but only by the exercise of intelligence, care, and common sense. It is therefore essential for the owner of this equipment to have personnel involved in the use and operation of these trailers who are competent, careful, physically and mentally qualified, and trained in the safe operation of this equipment.

Support Pad Requirements

The following is a list of recommendations and requirements for a concrete support pad. However, due to varying site conditions, the actual pad design should be prepared by an appropriately licensed structural or architectural engineer.

Recommended Support Pad Requirements

A full pad measuring 9'-0" x 40'-4", is the recommended support pad. The cross hatching as shown on [Figure 1: Pad Layout](#), [Figure 2: Right Side Elevation](#), and [Figure 3: Left Side Elevation](#) represents the recommended support pad.

Recommended Service Pad

A full pad measuring 29'-4-3/8" x 64'-4", is the recommended service pad. This will allow full service access to the mobile unit. The recommended service pad is shown on [Figure 1: Pad Layout](#), [Figure 2: Right Side Elevation](#), and [Figure 3: Left Side Elevation](#).

Support Pad Depth

Recommendations for the width and length of the pad are given above. Based upon the weight distribution of the mobile unit and existing site conditions, the depth should be determined by a local contractor.

Support Pad Levelness

In order to ensure proper operation of the system, the support pad(s) must be level and the deviation must not exceed 2" in 10'-0".

Vehicle Access

A firm, level surface is required around the mobile unit in order to provide access to the site, patient access to the mobile unit, and servicing of the mobile unit.

Recommended Attachment to the Facility

An inflatable air bag or soft seal is recommended at the point of connection from the unit to the facility. Fixed or solid connections may hinder imaging quality. Contact Oshkosh Specialty Vehicles or the local GE representative prior to construction if the proposed connection varies from the recommended.

Swing Clearance Note

Please verify the actual dimensions of the rearmost projections on the mobile self-propelled unit to the centerline of tandem suspension. Refer to [Figure 7: Turning Requirements](#) for proper turning requirements.

Radiation Shielding

IMPORTANT

Radiation exposure limits must be in accordance with all local, state, and federal requirements. It is the responsibility of the customer to perform a proper radiation survey in order to determine the exclusion zone.

Care should be taken when determining a site location. Factors such as shielding design, proximity to buildings, and occupancy of the surrounding areas must be considered. The mobile unit has been designed to provide radiation shielding for the areas adjacent to the procedure room. An exclusion zone around the mobile unit may be necessary. Please contact Oshkosh Specialty Vehicles for mobile unit specific shielding information.



Customer Power Requirements



It is the operator's responsibility to verify that the shore power receptacle is electrically compatible with the mobile unit's power cable and connector prior to connecting to the shore power connection. Plugging into a receptacle not electrically compatible could cause serious injury or damage.



The standard connector for the unit is a Russellstoll DS2504MP000/DF2032, (480V AC). If an existing site currently implements a different connector or connector configuration, please contact Oshkosh Specialty Vehicles in order to arrange for a compatible power connector before the unit leaves the facility.



Always inspect the power cable, connectors, and fasteners prior to usage. If during inspection, it is suspected that either internal or external damage has occurred, have a certified electrician inspect and repair the damage before using.



Follow the maintenance schedule in the Operator and Service Manual for safe operation of the mobile unit.

Lockout/Tagout

A Lockout/Tagout provision in accordance with OSHA Standard 1910.147 is required. The facility shore power disconnect device must be located within 40'- 0" of the unit and must provide for an effective lockout/tagout to facilitate safe service and maintenance of the unit.

Electrical Service

480V AC, three-phase, fused at 150 amps.

Configuration

Three-phase delta connection, four wire, with ground.

Load Regulation at Line Frequency

Wires are to be sized such that the line voltage drops from the power source to the mobile unit is less than 6% of the nominal voltage for the rated load of the mobile unit.

Frequency

60Hz \pm 0.5Hz.

Phase Balance

The phase balance is 2% maximum of lowest phase-to-phase voltage.

Maximum Voltage Variation

The maximum voltage variation is $\pm 2\%$ from a nominal steady state (under the worst case conditions of line voltage).

Connector Type

The mobile unit is supplied with a 50'-0" power cable and male connector. Unless otherwise specified, the 480V AC connector type is a Russellstoll DS2504MP000/DF2032.

Customer Facility

The customer facility must have the matching receptacle as specified in [Figure 5: Russellstoll Service Outlet](#), [Figure 6: Russellstoll 480V Chart](#). Unless otherwise specified, the 480V AC receptacle type to be used is a Russellstoll DF2504FRAB0.

Connector Notes

The standard connector for the mobile unit is a Russellstoll. The mobile unit is configured for 480V AC service. Many existing mobile sites are set up for a variety of different mobile units that this mammography clinic could utilize. Review the different site configurations to determine the best location for the mammography clinic on these sites. If an existing site currently implements a different connector, connector configuration, or the available power supply varies from the above specifications, please contact Oshkosh Specialty Vehicles to arrange for a compatible power connector before the mobile unit leaves the facility.

Voltage Surges

Transient voltage variations caused by external loads must not:

- Exceed $\pm 5\%$.
- Exceed five cycles duration.
- Occur more than ten times an hour.

Power Source Monitoring (Facility Only)

NOTE: Perform a power audit first.

A power analyzer should be used to check the proposed Mobile GE Senographe Series facility site power for average line voltage, surges, sags, reclosures, impulses, frequency and microcuts. A period that includes two weekends should be used to simulate several days of normal use. Analysis of the data and site history of any previous power problems with other X-ray systems or computer installations should be reviewed with your power and ground representative. Verify "brown-out" (low voltage) conditions, which may occur during summer months, will not exceed the allowable range.

Some analyzer models that are suitable for power monitoring are:

- Dranetz Model 658
- Dranetz Model 656A
- BMI 3630
- RPM

Mobile Grounding Requirements

IMPORTANT

All work is to be done in accordance with the local and national electrical codes.

IMPORTANT

Information shown here is only a recommendation and must be verified with both local and national site codes.

IMPORTANT

Ground wires inside enclosures are to be taped green for the entire visual length for identification purposes.

IMPORTANT

If a separately derived, secondary system transformer is used, a bonding jumper between the grounded conductor (neutral) and the equipment – grounding conductor must be used.

Special Ground Note

The mobile unit must have an earth driven ground rod within 5'-0" of the facility power receptacle. A grounding cable of a minimum #1/0 AWG must be connected between the grounding rod and the grounding pin of the facility power receptacle. A separate grounding conductor must still be run with the phase conductors to the source of the power from the grounding pin of the hospital power receptacle in accordance with NEC 2002 Article 250-24.

MOBILE GROUNDING REQUIREMENTS

NOTE:

- ALL WORK TO BE DONE IN ACCORDANCE WITH NATIONAL AND LOCAL ELECTRICAL CODES INFORMATION SHOWN HERE IS ONLY A RECOMMENDATION. MUST BE VERIFIED FOR SITE NATIONAL AND LOCAL CODES.
- GROUND WIRES INSIDE ENCLOSURES TO BE TAPED GREEN FOR ENTIRE VISUAL LENGTH FOR IDENTIFICATION.

1 MAIN BONDING JUMPER BETWEEN GROUNDED (NEUTRAL) CONDUCTOR AND EQUIPMENT GROUNDING CONDUCTOR TO BE PROVIDED IN FACILITY SERVICE EQUIPMENT AND DOWNSTREAM AT SEPARATELY DERIVED SYSTEM TRANSFORMER SECONDARY AS SHOWN.

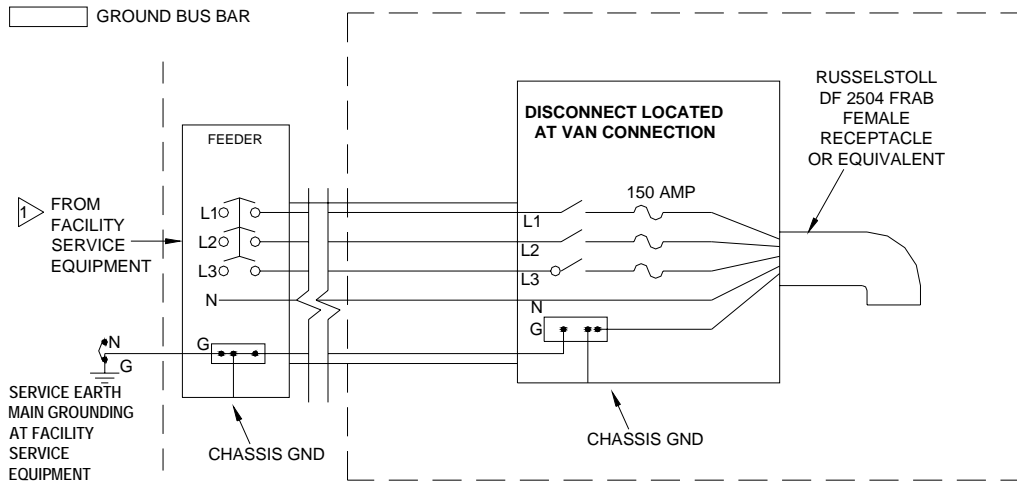

GROUNDING

The ground for our system shall originate at the system power source, i.e., transformer or first access point of power into a facility, and be continuous to our system power disconnect in the room. This ground can be spliced with "High Compression Fittings" and should be terminated at each distribution panel it passes through. When it is broken for a connection to a panel, it shall be connected into an approved grounding block with the incoming and outgoing ground in this same grounding block, which is then connected to the steel panel never using the steel panel never using the steel or other material of the panel as the block

The connection at the power source shall be at the grounding point of the "Neutral-Ground" if a "Wye" transformer is used, or typical grounding points of a separately derived system. In the case of an external facility, it shall be bonded to the facility ground point at the service entrance.

GROUNDING WIRE

The ground wire shall be copper wire with a minimum of AWG 1/0 or the same size as the power feeders whichever is larger. This means that if there is a primary feeder to a distribution panel of 500 MCM with a secondary feeder to our system of AWG 1/0 wire, the ground to the distribution panel shall be 500 MCM with and AWG 1/0 to our system. The ground wire impedance from our system disconnect, including the ground rod shall not have an impedance greater than 2 ohms to earth as measured by one of the applicable techniques described in Section 4 of ANSI/IEEE Standard 142-1982.

Harry E. Rauworth
Debra C. Balis
April 22, 1999

Telephone Service Requirements

Telephone Service

The mobile unit is supplied with one (1) telephone connection. The connector type that is used is an RJ-45 with CAT-5E cable. The cable measures 50'-0" in length.

Data Service

The mobile unit is supplied with one (1) data line connection that utilizes an RJ-45 outlet.

The data line connections require a 50'-0" CAT-5E cable with RJ-45 connections.

Water Requirements

Fresh Water Supply Requirements

The mobile unit has a 70-gallon fresh water tank. It is supplied with a $\frac{3}{4}$ " diameter, 20'-0" long hose terminated with a $\frac{3}{4}$ " female threaded hose connector located on the rear left side of the mobile unit. The facility must provide a $\frac{3}{4}$ " male connector and a water supply that meets the following specifications:

- A flow rate of 5 gallons per minute.
- 45-60 PSI.
- A maximum temperature of 70°F.

The 70-gallon tank supplies the GE Smart Water System.

Water Tank Drain Connections

The mobile unit will be supplied with a $\frac{3}{4}$ " diameter, 20'-0" long hose terminated with a $\frac{3}{4}$ " male threaded hose connector located on the right side of the mobile unit. The facility must provide means of water drainage from the system, which complies with all local applicable codes.

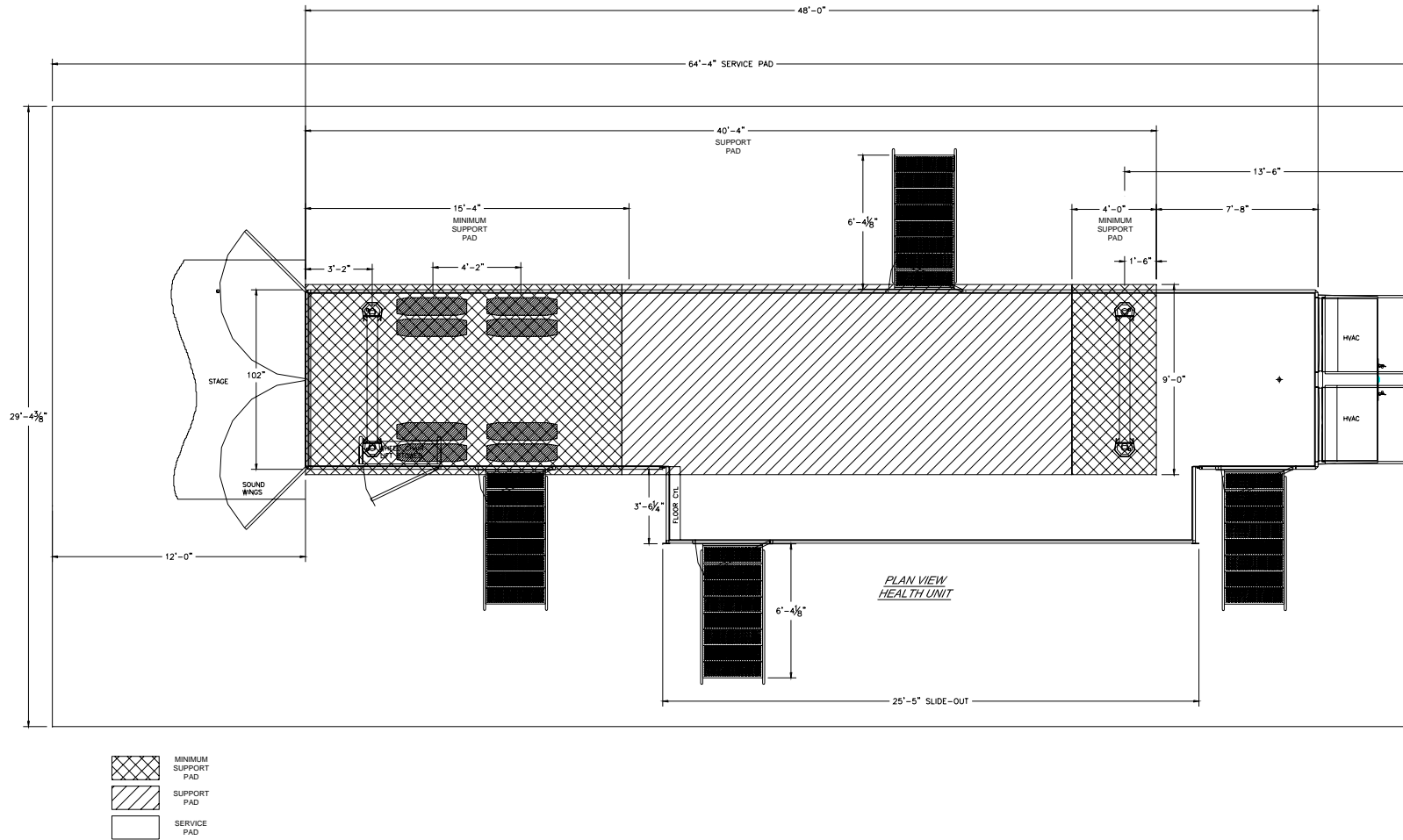

Figure 1: Pad Layout

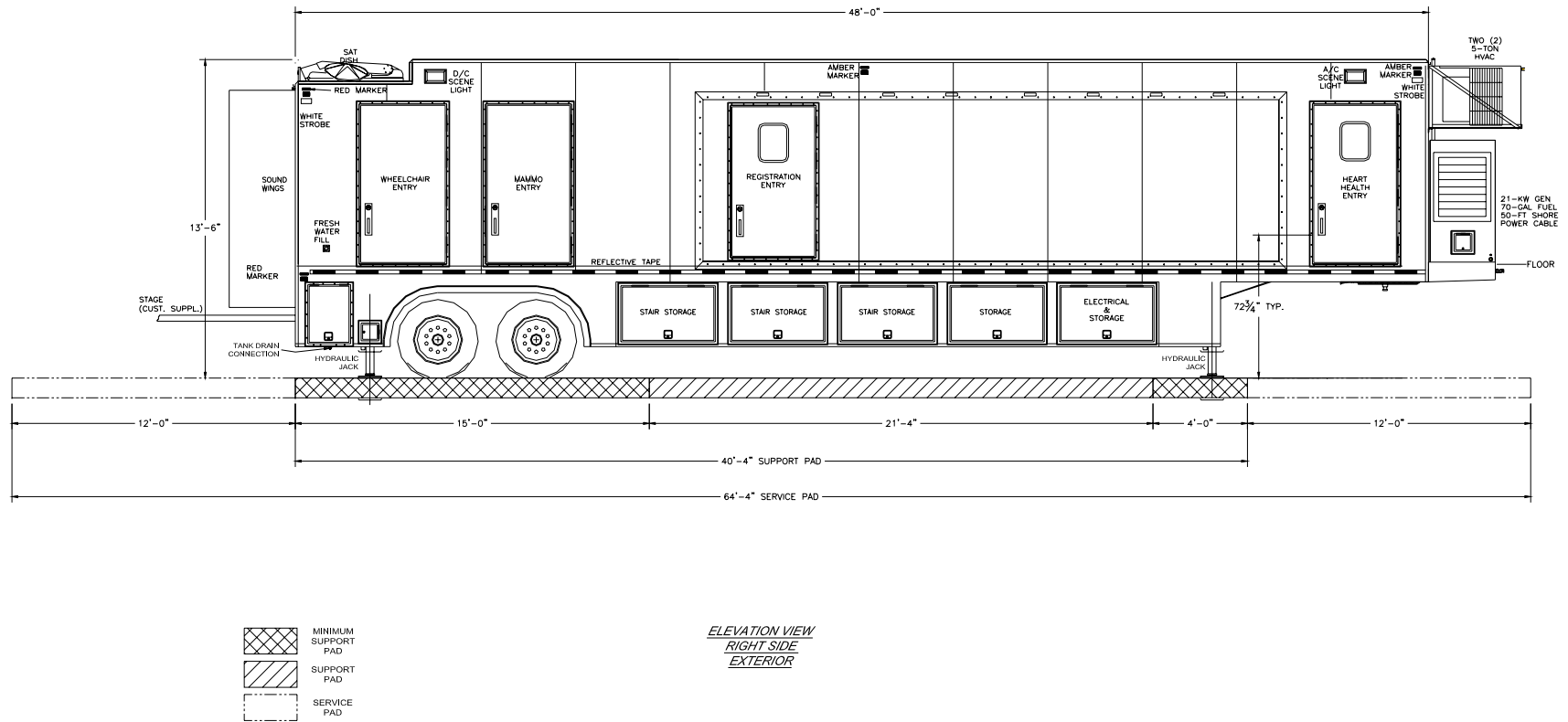

Figure 2: Right Side Elevation

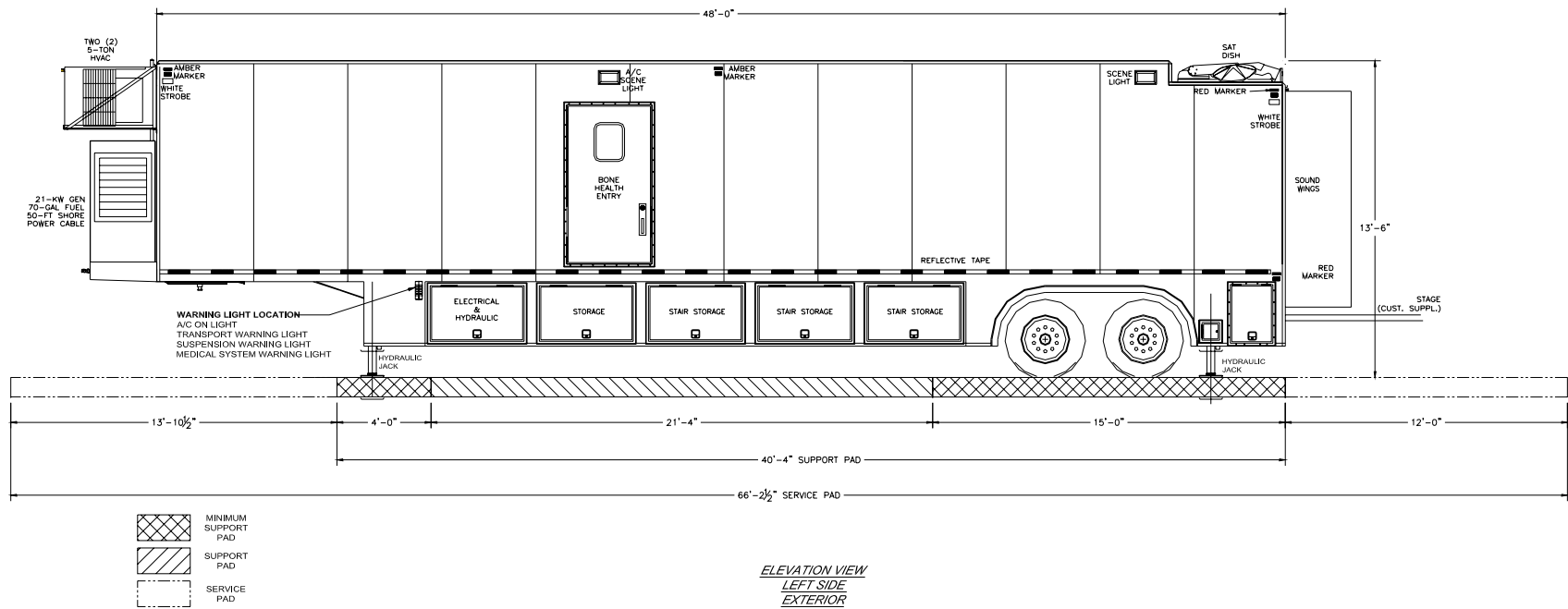

Figure 3: Left Side Elevation

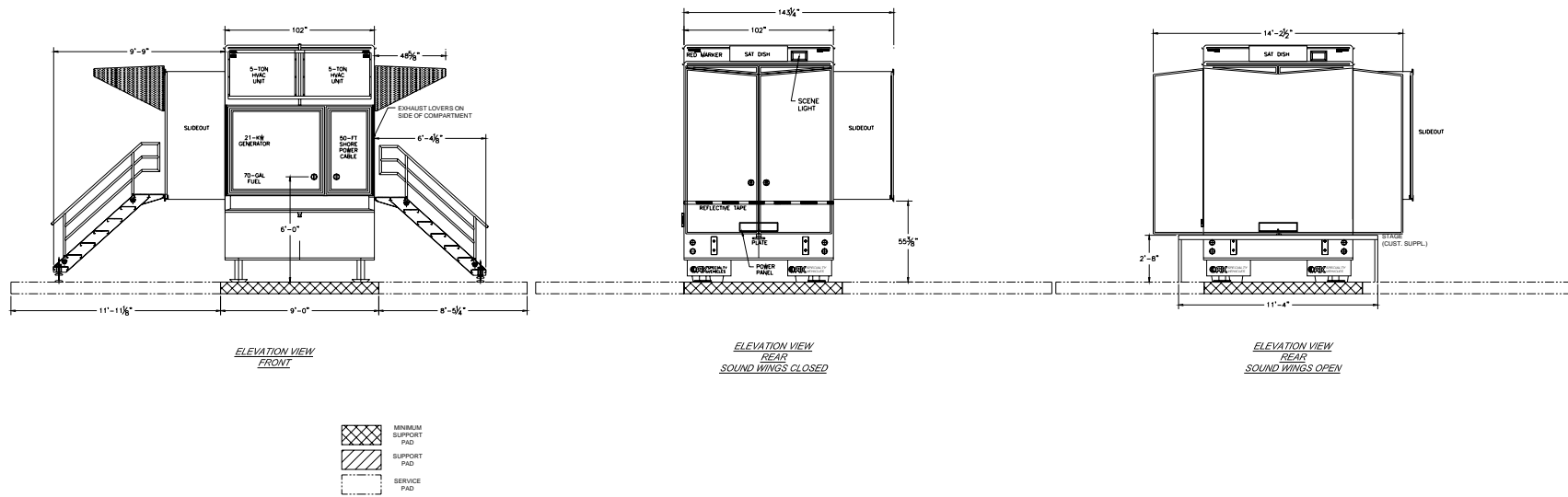

Figure 4: Rear Side Elevation

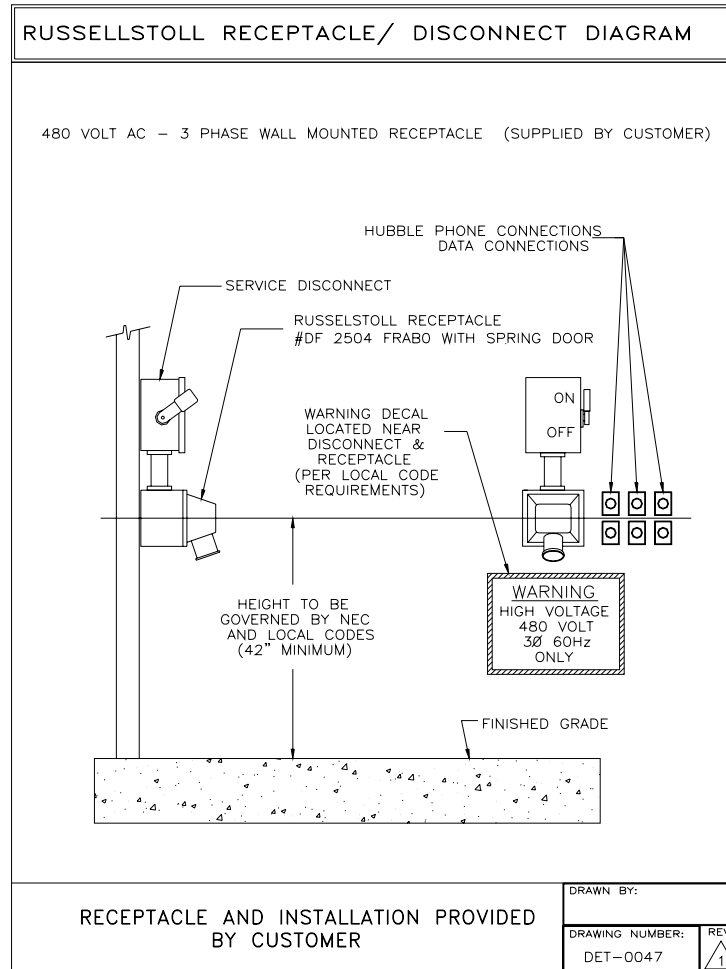

Figure 5: Russellstoll Service Outlet

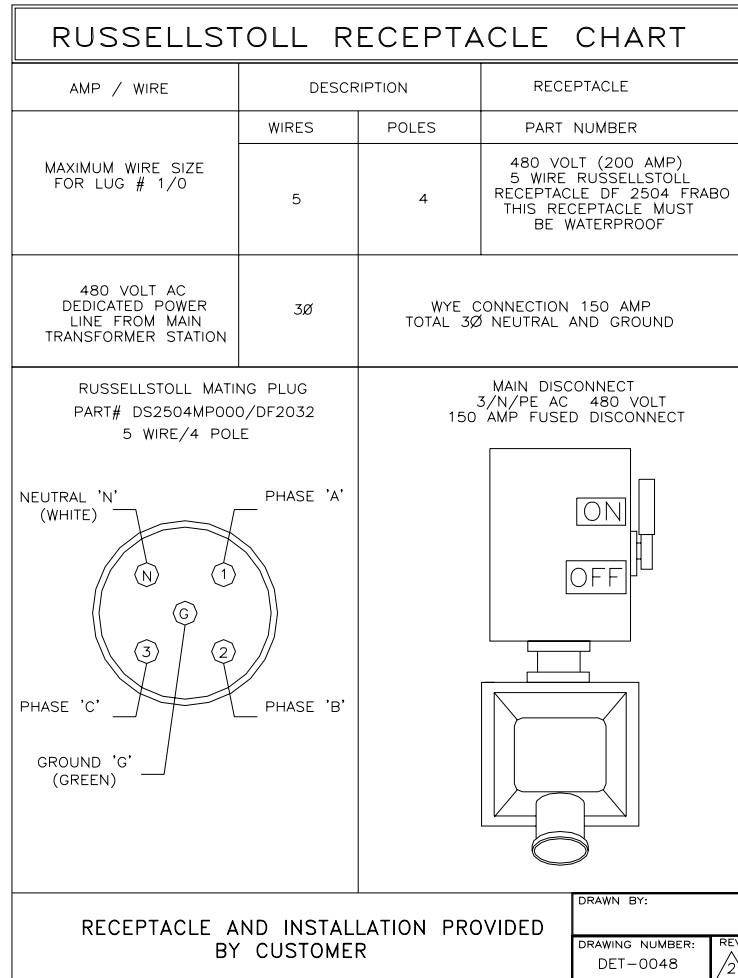

Figure 6: Russellstoll 480V Chart

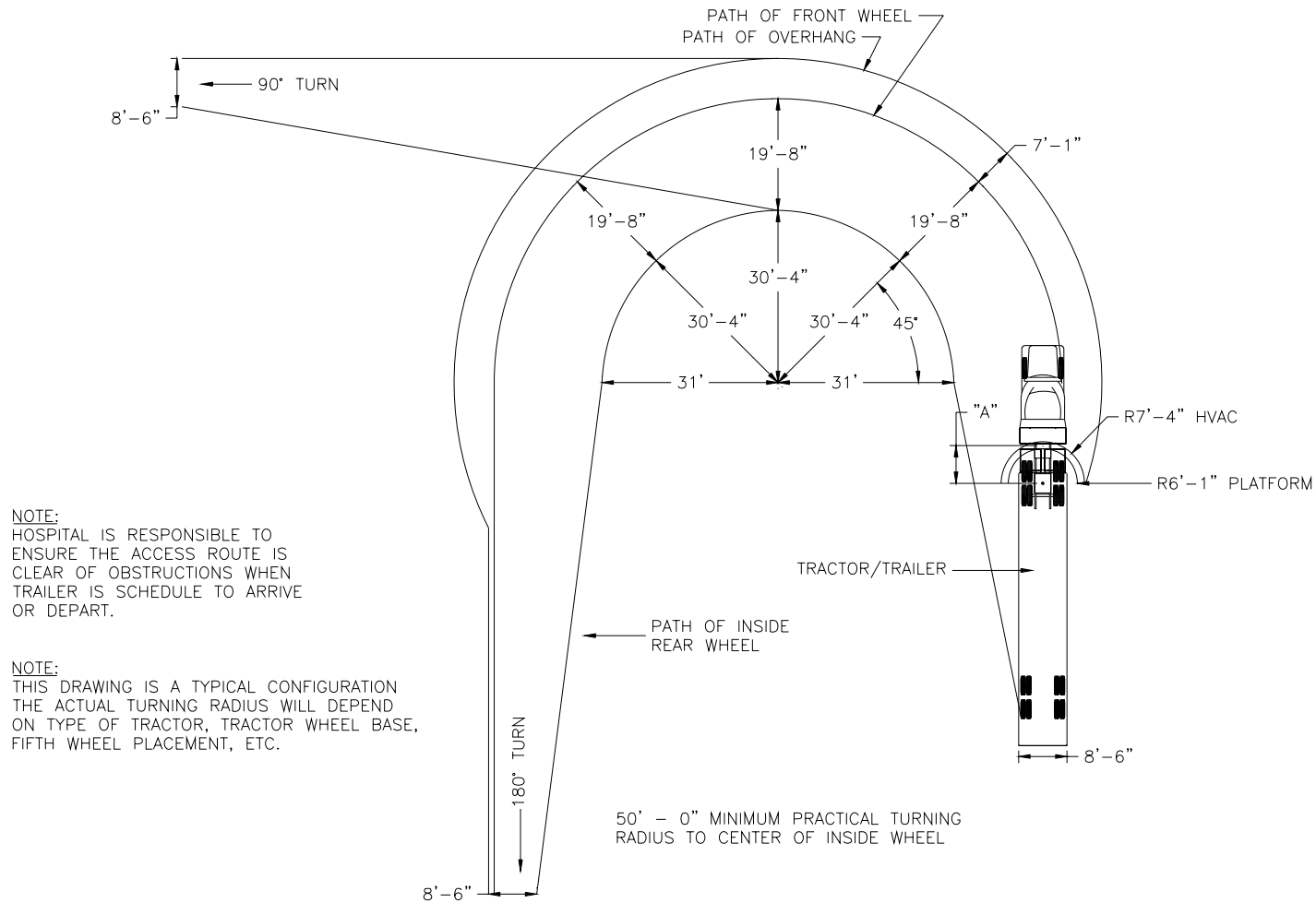

Figure 7: Turning Requirements