

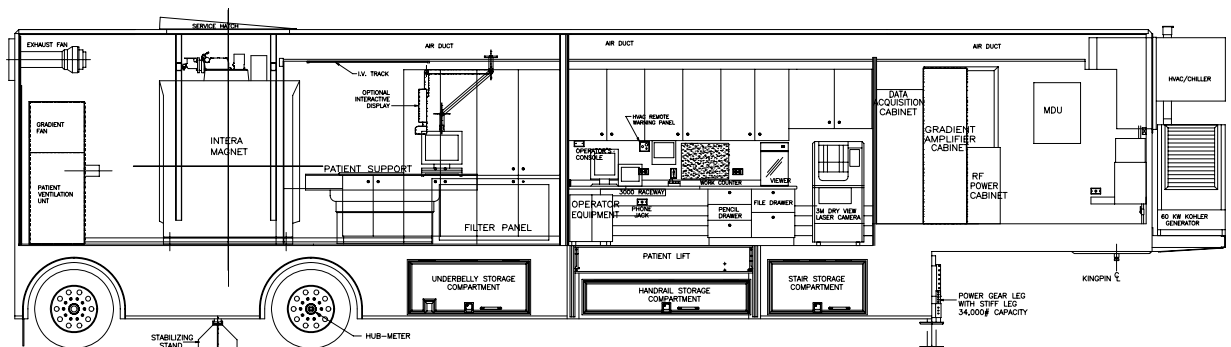

Site Planning Guide

PHILIPS 1.0T / 1.5T Mobile MRI Systems 48' L x 8'-6" W x 13'-6" H USA Unit



© 2006 Oshkosh Specialty Vehicles

This guide contains confidential information of Oshkosh Specialty Vehicles. You may not copy it or any part of it without the written permission of Oshkosh Specialty Vehicles. This manual may be used only by you, and only for the purposes for which it was intended. You may not disclose this manual or the confidential information it contains outside of your company. If you wish to copy any part of this manual, or to use it other than as described above, you must contact Oshkosh Specialty Vehicles seeking permission to do so.

North America

Corporate Headquarters
Oshkosh Specialty Vehicles
16745 South Lathrop Ave.
Harvey, IL
60426
USA
(001) 708.596.5066

Europe

Oshkosh Specialty Vehicles, Ltd.
Unit 17, Nelson Way
Tuscum Trading Estate,
Camberley Surrey
GU15 3DH
United Kingdom
(44) 01276.64490

Buys Ballotstraat 6
3261 LA Oud-Beijerland, Holland
+31 (0) 186-614322
Fax. +31 (0) 186-619367
E-mail: smit@smit-mobile.nl

List of Revisions

Revisions

01	Initial Release	October 2001
02	Inc.LO/TO, updated Dwgs	September 2002
03	Added Ground Connection Clarification	January 2003
04	Added Crouse Hinds Power Plug Option	April 2003
05	Removed System Reference, Added Weights	March 2006
06	Patient to Platform	August 2006
07	Updated Logo & Company Reference	October 2006

Notice

In accordance with our policy of continued product improvement, Oshkosh Specialty Vehicles reserves the right to make changes in the equipment, design, specifications, and materials of the product described herein. Any problems or questions related to the components or systems covered in this booklet may be directed to:

Oshkosh Specialty Vehicles
Attention: Service Department
16745 South Lathrop Avenue
Harvey, Illinois
60426
USA

Telephone – service: (001) 800.839.0630 (24/7)
Fax: (001) 708.596.2480

<http://www.oshkoshsv.com>

Table of Contents

<u>Introduction.....</u>	<u>6</u>
Warnings & Safety Alert Conventions	6
<u>Support Pad Requirements</u>	<u>7</u>
Trailer Weight	7
Minimum Support Pad Requirements	7
Recommended Support Pad Requirements	7
Support Pad Depth.....	7
Support Pad Levelness	7
Recommended Service Pad.....	7
Vehicle Access	8
Steel Reinforced Concrete Pad.....	8
Recommended Attachment to the Facility	8
Vehicle Movement.....	8
Exclusion Zone	8
Vibration / Foundation Design	8
Swing Clearance Note.....	8
<u>Customer Power Requirements</u>	<u>9</u>
Lockout/Tagout.....	9
Electrical Service	9
Configuration	9
Frequency.....	9
Phase Balance	9
Maximum voltage variation.....	9
Connector Type	10
Customer Facility.....	10
Voltage Surges	10
Power Source Monitoring (Facility Only).....	10
Ground Conductor.....	10
Magnetic Shielding	11
R.F. Shielding	11
<u>Mobile Grounding Requirements</u>	<u>12</u>

Special Grounding Note:..... 12

Telephone and Data Service Requirements 13

Telephone Service..... 13

Data Service 13

Water Requirements 14

Humidifier Water Fill 14

Water Supply Requirements (Sink Option)..... 14

Waste Water Connections (Sink Option)..... 14

Table of Figures

Figure 1: Ground Connection.....	12
Figure 2: Pad Layout.....	15
Figure 3: Right Side Elevation	16
Figure 4: Left Side Elevation.....	17
Figure 5: Stair/Lift/Wall Elevation.....	18
Figure 6: Russellstoll Service Outlet.....	19
Figure 7: Russellstoll Chart.....	20
Figure 8: Crouse Hinds Service Outlet (Option)	21
Figure 9: Crouse Hinds Chart (Option)	22
Figure 10: Turning Requirements	23

Introduction

The purpose of this document is to provide the basic information needed for site planning. For specific information not contained in this document, please contact Oshkosh Specialty Vehicles.

The mobile unit requires sufficient room to be maneuvered and positioned for setup and takedown. The mobile unit has many storage compartments and service doors that require access during these procedures as well as during operation. The platform lift, entry stair and optional platform require additional space on the right side of the mobile unit. Refer to the drawings provided for actual locations of doors, platform lift, and stair sizes and locations.

Warnings & Safety Alert Conventions

Three types of statements are used throughout this document to warn the operator of potential situations. Always read these statements carefully and take the appropriate safety precautions to ensure a safe environment for all personnel and all property. The statements are as follows:



This type of notice indicates a potentially hazardous situation, which if not avoided, could result in injury or death to the operator of the mobile unit.



This type of notice indicates a potentially hazardous situation, which if not avoided, could result in irreparable damage to the mobile unit.



This type of notice is meant to inform the operator of useful information.

Support Pad Requirements

The following is a list of recommendations and requirements for a concrete support pad. However, due to varying site conditions, the actual pad design should be prepared by an appropriately licensed structural or architectural engineer.

Trailer Weight

The weight of the trailer should be considered in the design of the support and service pads. The overall weight of the trailer is approximately 58,420 lbs. The weight on the rear axles is approximately 36,500 lbs. The weight on the King Pin is approximately 21,920 lbs.

Minimum Support Pad Requirements

A front pad measuring 4'-6" x 11'-0" and a rear pad measuring 15'-2-1/2" x 11'-0" will provide the minimum support pad requirements. The smallest cross-hatching as shown on [Figure 2: Pad Layout](#) and [Figure 3: Right Side Elevation](#) represents the minimum support pad.

Recommended Support Pad Requirements

A full pad measuring 52'-5" x 11'-0" is the recommended support pad. The cross-hatching as shown on [Figure 2: Pad Layout](#) and [Figure 3: Right Side Elevation](#), represents the recommended support pad.

Support Pad Depth

Recommendations for the width and length of the pad are given above. Based upon the existing site conditions, the depth should be determined by a local contractor.

Support Pad Levelness

In order to ensure proper operation of the MRI system, the support pad(s) must be level and the deviation must not exceed .125" in 10'-0". If the minimum support pads are used instead of the recommended support pad, they must also meet this specification.

Recommended Service Pad

A service pad is recommended to provide adequate service access. The recommended size of the pad is 60' x 18'. See [Figure 2: Pad Layout](#) for details.

Vehicle Access

A firm, level surface is required around the mobile unit in order to provide access to the site, patient access to the mobile unit, and servicing of the mobile unit.

Steel Reinforced Concrete Pad

Nonferrous reinforcement materials are recommended. If ferrous materials are used contact Philips for the maximum weight allowed per foot.

Recommended Attachment to the Facility

An inflatable air bag or soft seal is recommended at the point of connection from the unit to the facility. Fixed or solid connections may hinder imaging quality. Contact Oshkosh Specialty Vehicles or the local Philips representative prior to construction if the proposed connection varies from the recommended.

Vehicle Movement

The MRI system is very sensitive to vibration and moving metal. Consequently, all vehicle traffic must be kept as far away as possible from the pad. Moving ferrous materials having the listed masses should be limited to areas as described in the Philips site planning publication. Contact Philips to obtain the latest version.

Exclusion Zone

An area of 5'-0" x 5'-0", located directly below the magnet vent should be fenced off to prevent injury in the event of magnet quenches. The helium gas must be allowed to vent, unrestricted, to a non-accessible area, allowing the helium gas to dissipate.

Vibration / Foundation Design

Please contact Philips Medical Systems for the latest system specific vibration requirements.

Swing Clearance Note

Please verify the actual dimensions of the rearmost projections on the cab of your tractor to the centerline of tandem suspension or centerline of the fifth wheel plate on your tractor. Refer to [Figure 10: Turning Requirements](#) for proper tractor sizing information.

Customer Power Requirements



It is the operator's responsibility to verify that the shore power receptacle is of the same type and voltage as the connection that is supplied by Oshkosh Specialty Vehicles. Failure to do this can result in injury or death to the operator of the mobile unit as well as irreparable damage to the mobile unit.



The standard connector for the unit is a Russellstoll #DS2504 MP000/DF2032. If an existing site currently implements a different connector or connector configuration, please contact Oshkosh Specialty Vehicles in order to arrange for a compatible power connector before the unit leaves the facility.

Lockout/Tagout

A Lockout/Tagout provision in accordance with OSHA Standard 1910.147 is required. The facility shore power disconnect device must be located within 40'- 0" of the unit and must provide for an effective lockout/tagout to facilitate safe service and maintenance of the unit.

Electrical Service

A single electrical power source is required for operation of the MRI system.
480 Volt A.C., 3 Phase, ABC Phase Rotation, 125 KVA, fused at 150 Amps

Configuration

Three phase, five wire, wye connection, with ground and neutral (not less than AWG #1/0).

Frequency

60 Hz \pm 2.0%

Phase Balance

The phase balance is + 2% maximum phase-to-phase line voltage difference lowest phase.

Maximum voltage variation

The maximum voltage variation is + 4.5% / -12.5% from nominal steady state (under the worst case conditions of line voltage)

Connector Type

The unit is supplied with a 50-foot cable and male connector. The connector is a Russellstoll 200 Amp plug #DS2504MP000/DF2032.

Customer Facility

The facility must have the matching receptacle as specified in [Figure 6: Russellstoll Service Outlet](#) and [Figure 7: Russellstoll Chart](#). The receptacle is a Russellstoll #DF2504FRAB0.

Voltage Surges

Transient voltage variations caused by external loads must not:

- Exceed + 5%
- Exceed five cycles duration
- Occur more than ten times an hour.

Power Source Monitoring (Facility Only)

NOTE: Perform a power audit first.

A power analyzer should be used to check the proposed Mobile MRI Series facility site power for average line voltage, surges, sags, reclosures, impulses, frequency and microcuts. A period that includes two weekends should be used to simulate several days of normal use. Analysis of the data and site history of any previous power problems with other X-ray systems or computer installations should be reviewed with your power and ground representative. Verify “brown-out” (low voltage) conditions, which may occur during summer months, will not exceed the allowable range.

Some analyzer models that are suitable for power monitoring are:

- Dranetz Model 658
- Dranetz Model 656A
- BMI 3630
- RPM

Ground Conductor

An insulated ground conductor sized in accordance with National, State, and local codes shall be installed between the facility vault and the MRI System ground bus location in the power distribution unit.

Magnetic Shielding

The MRI unit is equipped with magnetic shielding. The exclusion zone for cardiac pacemakers, neurostimulators, and other biostimulation devices is recommended at 5 gauss (0.5mT). Signs provided by Philips, must be posted to alert all who approach the unit of this requirement. The appropriate warning signs are permanently attached to the scan room doors.

The 1.0T and 1.5T magnet systems exclusion zone (5) gauss is restricted to within 6" of the exterior of the mobile unit.

R.F. Shielding

The R.F. shield is included with the MRI system and will provide the minimum level of attenuation, 10Mhz – 100Mhz, at 100db (plane wave, electric field, magnetic wave).

Mobile Grounding Requirements

Special Grounding Note:

The unit must have an earth driven ground rod within five (5) feet of the hospitable power receptacle. A grounding cable of a minimum #1/0 AWG must be connected between the grounding rod and the grounding pin of the hospitable power receptacle. Another cable to be kept as short as possible, may also be connected between the ground stud on the Incoming Power Distribution Panel and an earth driven ground rod. See [Figure 1: Ground Connection](#) below. A separate grounding conductor must still be run with the phase conductors to the source of power from the grounding pin of the hospitable power receptacle in accordance with NEC 2002 Article 250-24.

NOTE: For the associated drawing please refer to the following chart for grounding requirements.



[Figure 1: Ground Connection](#)

Telephone and Data Service Requirements

Telephone Service

The mobile unit is supplied with three (3) telephone connections.

The connector type that is used and supplied by Oshkosh Specialty Vehicles is an all-weather Hubbell PH-6595 (inlet) with a model PH-6624 connector body.

The customer is required to purchase and install three (3) all weather Hubbell PH-6597 phone outlets for use at the site.

Three all weather Hubbell PH-6599, 50'-0" telephone connecting cables are included with the unit. If additional cables are required, the customer must purchase them.

Data Service

The mobile unit is supplied with three data line connections that utilize RJ-45 outlets.

The customer is required to purchase the data connection cables for use with the data line connections. The data line connections each require a 50'-0" CAT-5E cable with RJ-45 connections.

Water Requirements

IMPORTANT

During winter conditions, provisions must be made to ensure that no water lines freeze due to weather conditions.

Humidifier Water Fill

The mobile unit contains a water storage tank for the humidifier. This tank is located in the equipment room and must always contain water to insure the specified humidity level remains constant. There are two options for filling the tank.

- A $\frac{3}{4}$ " I.P.S. male threaded hose connection is located under the front kick of the mobile unit, below the air conditioning units.
- A fill port is located on the water tank itself for manual fill capability.

Water Supply Requirements (Sink Option)

The mobile unit will be supplied with a $\frac{3}{4}$ " diameter, 20'-0" long hose terminated with a $\frac{3}{4}$ " I.P.S. male threaded hose connector located on the left side of the mobile unit. The facility must provide a $\frac{3}{4}$ " female connector and a water supply that meets the following specifications:

- A flow rate of 5 gallons per minute.
- 45-60 PSI.
- A maximum temperature of 70°F.

Waste Water Connections (Sink Option)

A $1\frac{1}{2}$ " IPS male connection is required to sink wastewater.

Any pipes and drains within 20'-0" of the magnet isocenter should be of non-ferrous materials such as PVC, copper, or brass. All plumbing must comply with all applicable codes.

The mobile unit is supplied with a 20'-0" long $1\frac{1}{2}$ " diameter hose that is terminated with a $1\frac{1}{2}$ " male threaded connector for sanitary wastewater drainage located on the left side of the mobile unit. The facility must provide means of sanitary wastewater drainage from the system, which complies with all local applicable codes.

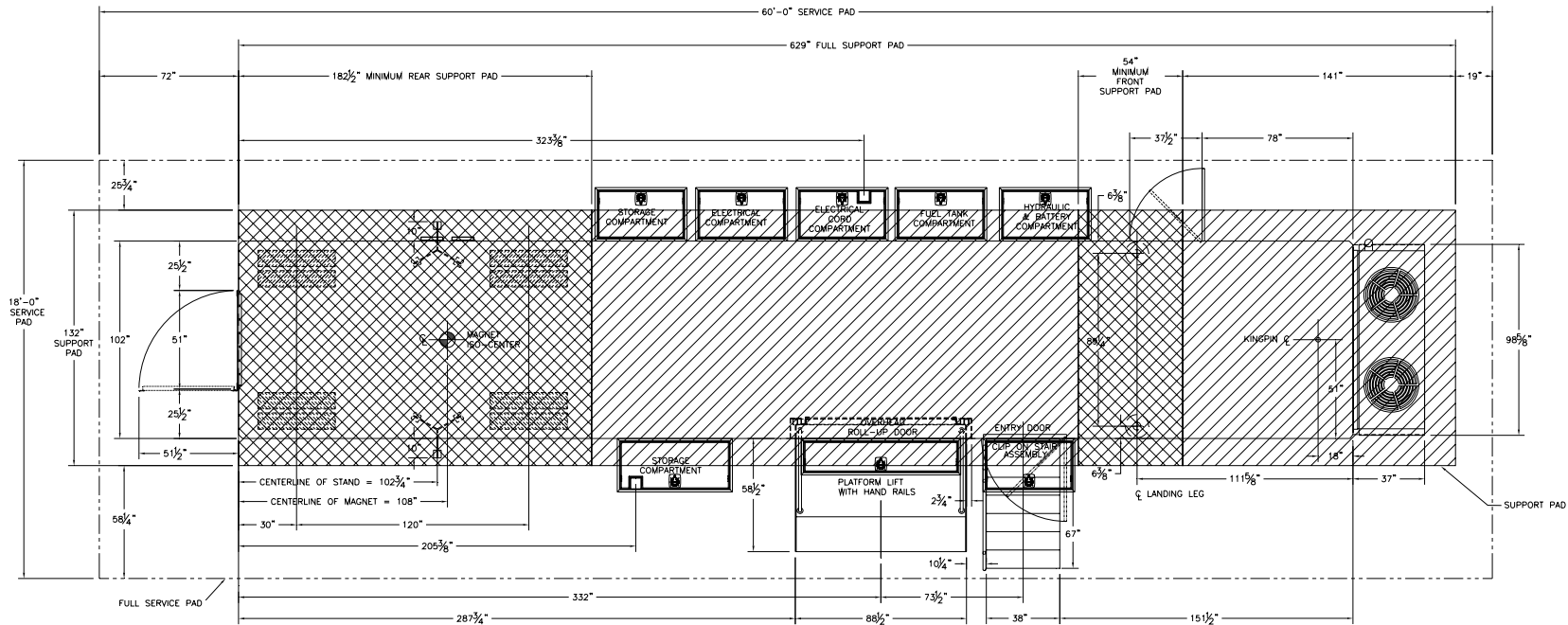

PLAN VIEW

Figure 2: Pad Layout

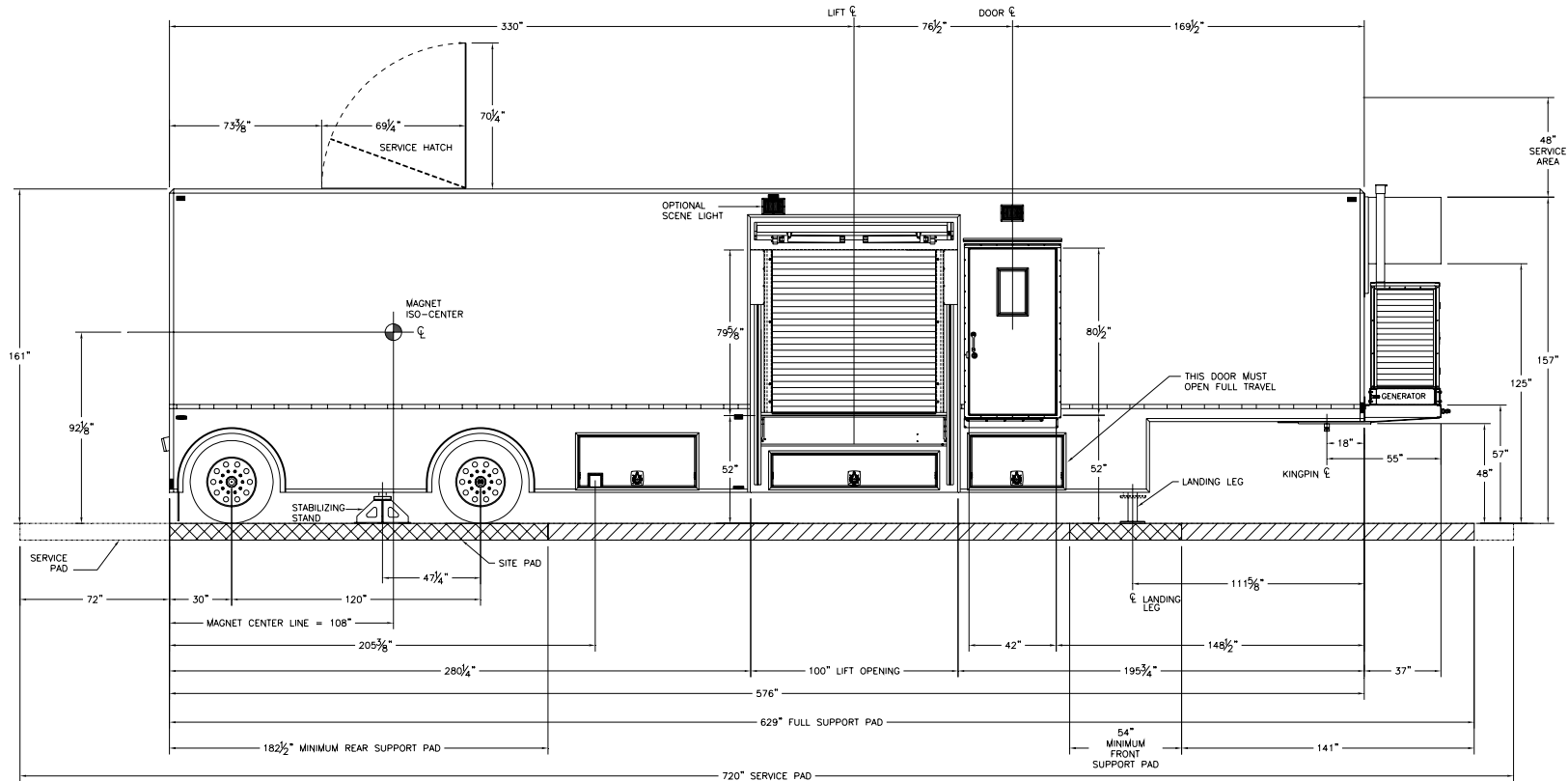

RIGHT SIDE ELEVATION

Figure 3: Right Side Elevation

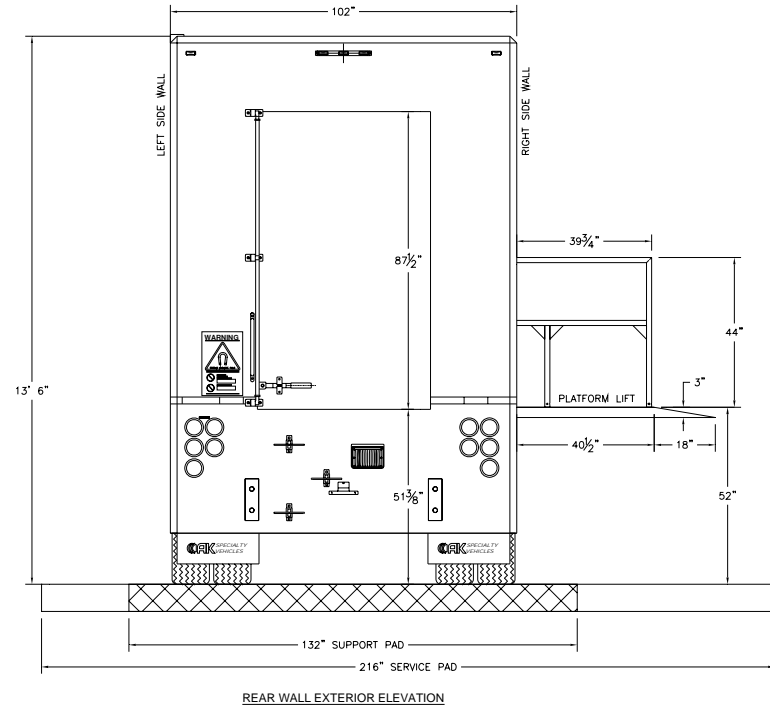
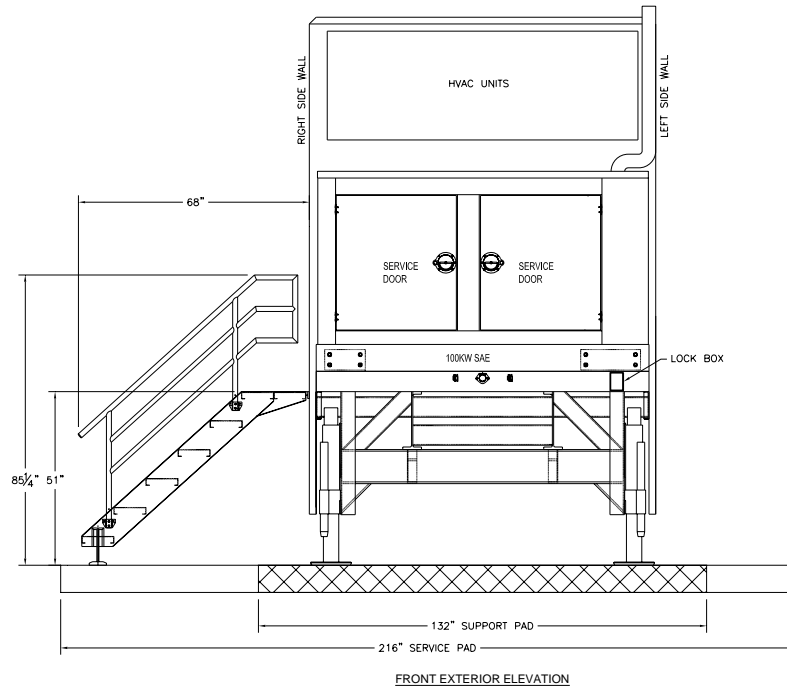

Figure 5: Stair/Lift/Wall Elevation

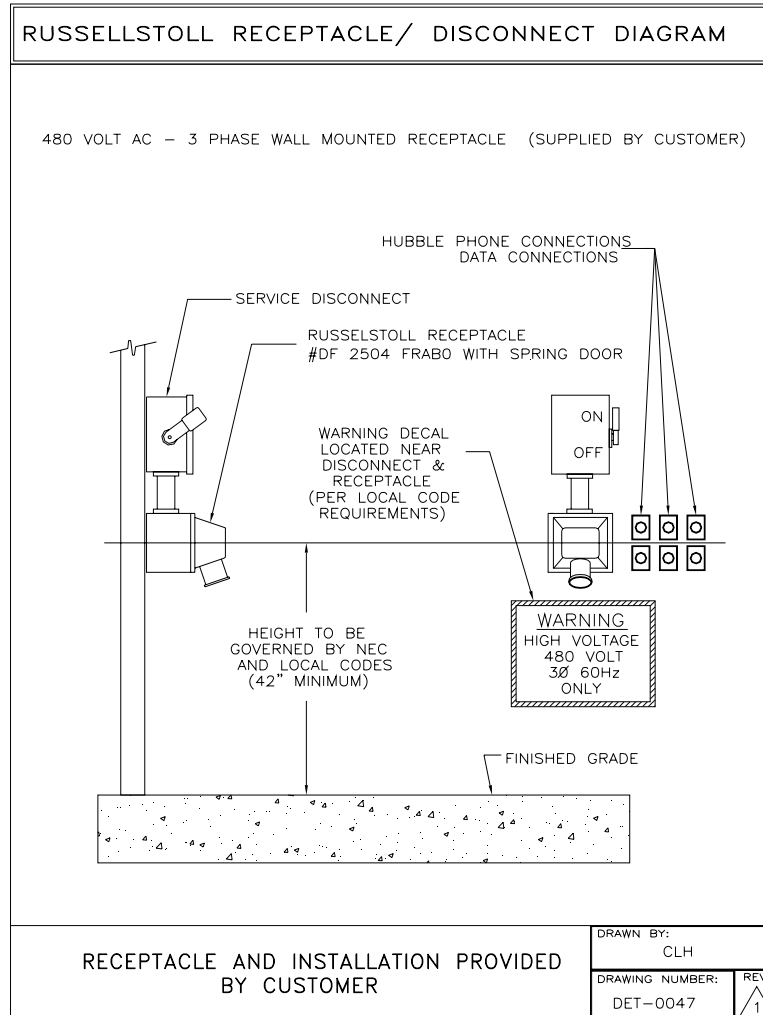

Figure 6: Russellstoll Service Outlet

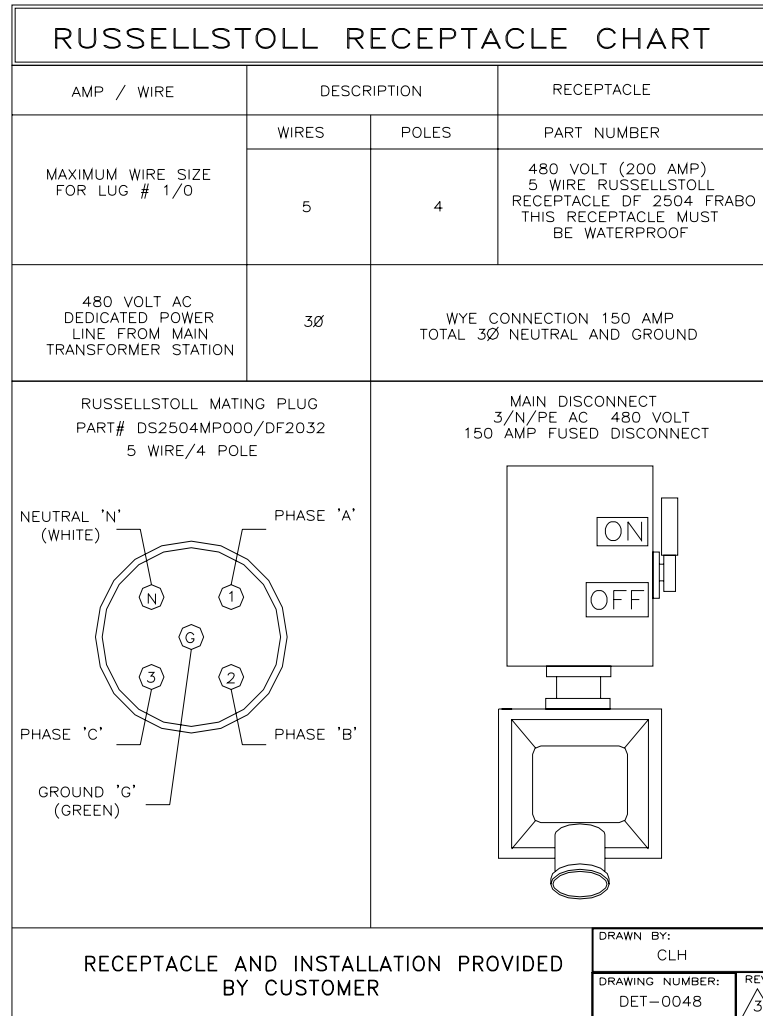

Figure 7: Russellstoll Chart

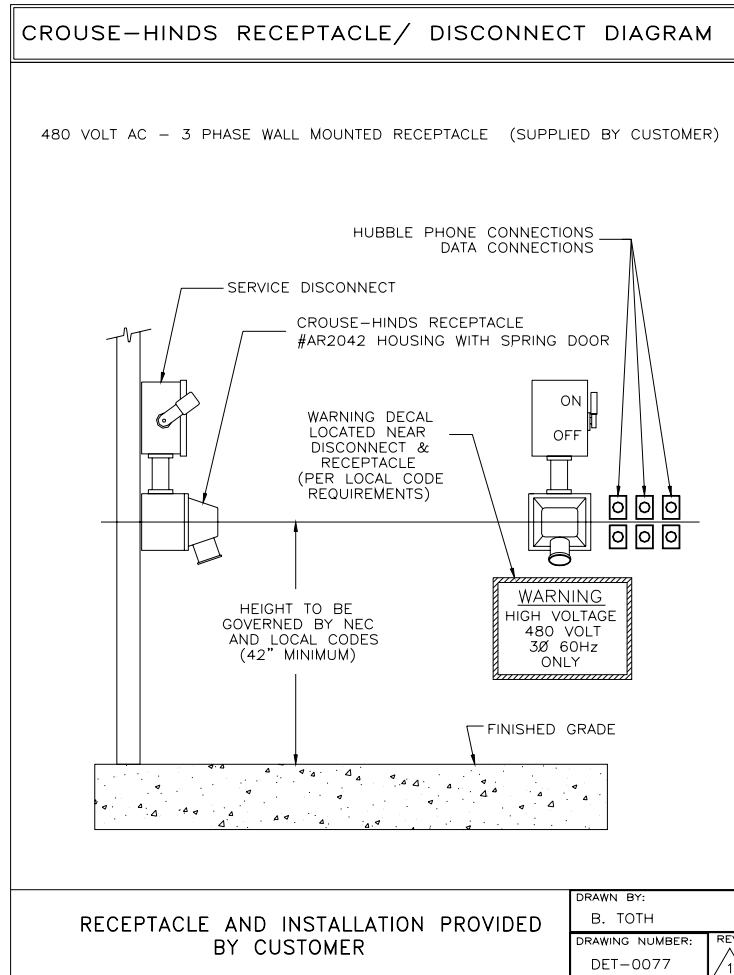

Figure 8: Crouse Hinds Service Outlet (Option)

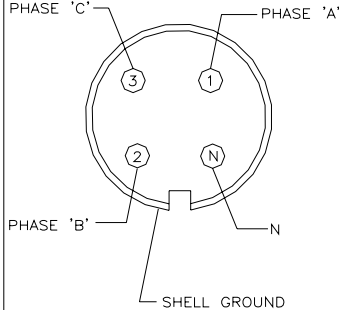
CROUSE-HINDS RECEPTACLE CHART			
AMP / WIRE	DESCRIPTION		RECEPTACLE
	WIRES	POLES	PART NUMBER
MAXIMUM WIRE SIZE FOR LUG # 1/0	4	3	480 VOLT (200 AMP) 4 WIRE CROUSE-HINDS RECEPTACLE AR2042 HOUSING THIS RECEPTACLE MUST BE WATERPROOF
480 VOLT AC DEDICATED POWER LINE FROM MAIN TRANSFORMER STATION	3Ø	WYE CONNECTION 150 AMP TOTAL 3Ø NEUTRAL AND GROUND	
CROUSE-HINDS MATING PLUG PART# AP 20467 3 WIRE/4 POLE (GROUNDED THROUGH EXTRA POLE AND SHELL)		MAIN DISCONNECT 3/N/PE AC 480 VOLT 150 AMP FUSED DISCONNECT	
			
RECEPTACLE AND INSTALLATION PROVIDED BY CUSTOMER			DRAWN BY: B. TOTH DRAWING NUMBER: DET-0078
			REV 1

Figure 9: Crouse Hinds Chart (Option)

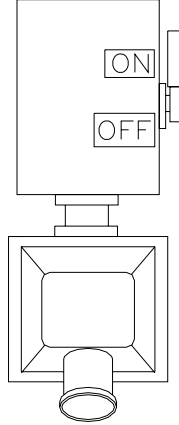
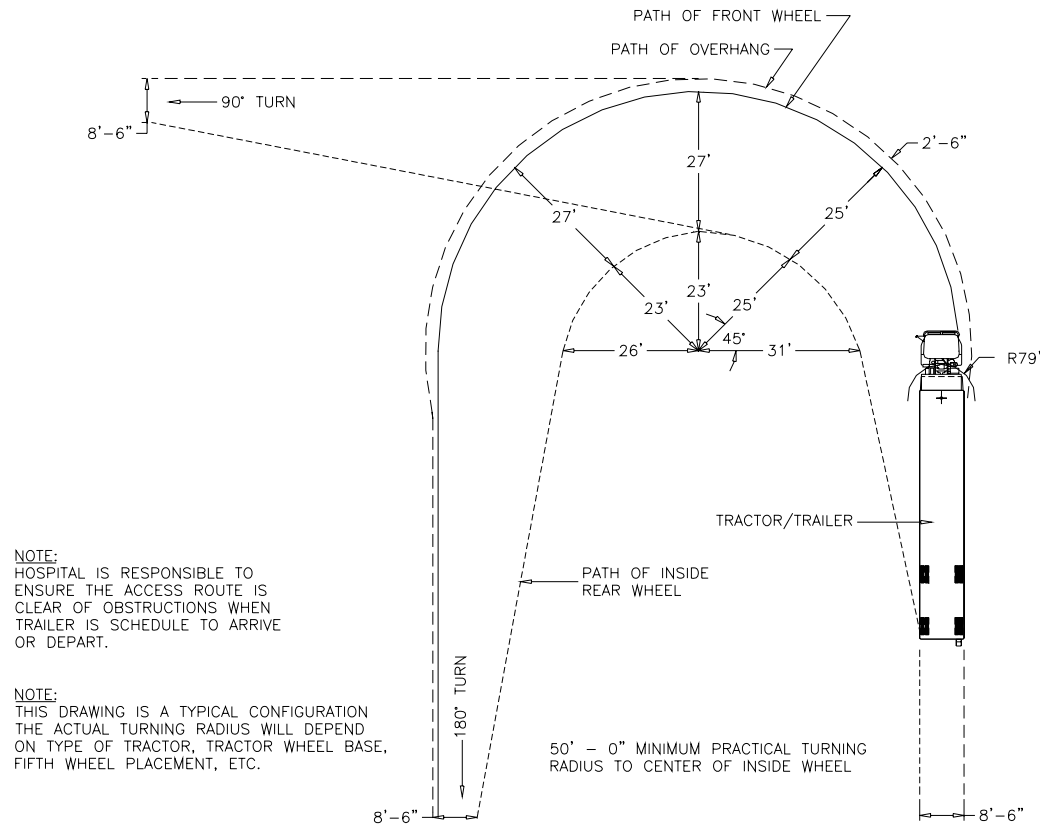

A minimum dimension of 79" is required from the rearmost projection to the centerline of the kingpin. This provides swing clearance for the generator, which is mounted on the front of the mobile unit. The facility is responsible to ensure the access route is clear of obstructions when the mobile unit is scheduled to arrive or depart. The 50'-0" minimum outside turning radius shown here has been calculated using an International Harvester (Navistar) tractor, model COF-9670 with a 161" wheelbase. The turning radius will vary according to the towing tractor that is being used. The customer must confirm the turning radius on their tractor and prepare each site with adequate space to accommodate it.

Figure 10: Turning Requirements